

XDL4WM 4.0" x 4.5" Linear Wall Mount



PROJECT _____

CATALOG # _____

TYPE _____

Features

- Tool-Less Entry
- High efficacy and lifespan LEDs
- 2 piece wall bracket allows for easy and secure wall installation.

Description

The XDL4WM is an LED linear wall mount fixture, design with quality craftsmanship. Engineered for quick and easy tool-less installation. The XDL series provides clean lines, smooth continuous runs, and tight lens fitment. Available in continuous runs and custom angles and lengths.

Construction

Constructed of a precision cut, proprietary aluminum extrusion with flat end caps. Internal joiner system. Available in any length with a 2' minimum.

Tool-less Entry

LED Board tray clips in with quick release holders, and held on by tethers. Releasing the clips drops and holds the board tray, allowing quick, tool-less, and easy wiring of the fixture.

Mounting

2 piece wall innovative wall mounting system allows for quick and easy mounting.

LEDs

High Output LEDs are available in 2700K, 3000K, 3500K, 4000K, and 5000K color temperatures. Integral LEDs are rated for at least 100K life hours (L70).

Optics

Snap-in satin acrylic lens fully diffuses the appearance of the LEDs and provides excellent light transmission.

Driver

0-10V dimming driver included standard. Driver options available for 1% dimming, Lutron EcoSystem, and DALI.

Finish

Matte white finish standard. Custom finish options are available in various RAL colors.

Options

Various options are available. If hanging canopies are ordered, one power feed and one non-power feed per fixture should be ordered. If additional or custom options are needed, consult factory.

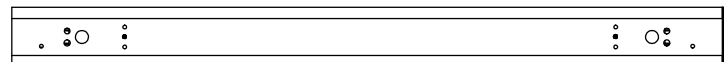
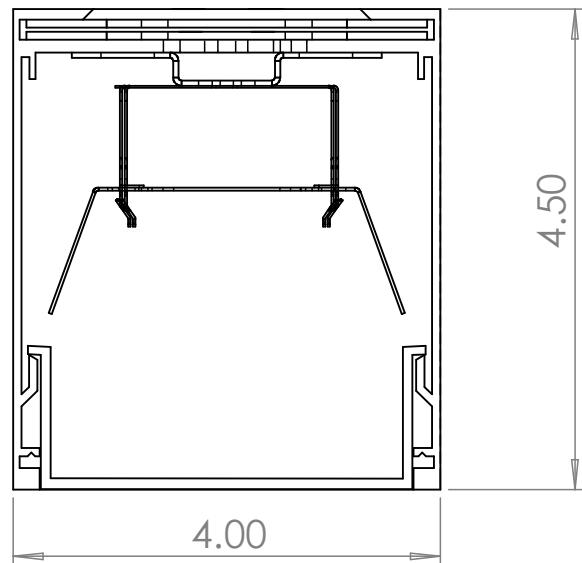

XDL4WM 4.0" x 4.5" Linear Wall Mount



ORDERING INFORMATION

Example: XDL4WM-40-7L-M-W-4
 With options: XDL4WM-40-7L-M-W-4-12EBL

Fixture	CCT	Output	Voltage	Finish	Length
XDL4WM	■ 27 2700K	■ 5L 500 Lm/Ft	■ M Multi-Volt (120-277V)	■ W Matte White	■ 2 2 ft
	■ 30 3000K	■ 7L 700 Lm/Ft		■ SP Special Finish	■ 3 3 ft
	■ 35 3500K	■ 10L 1000 Lm/Ft			■ 4 4 ft
	■ 40 4000K	■ 14L 1400 Lm/Ft			■ 5 5 ft
	■ 50 5000K	■ XXXXL XXXX Lm/Ft			■ 6 6 ft
				■ 7 7 ft	
				■ 8 8 ft	
				■ XX XX ft	

Options: Add to end of part number

Driver Options	Options
■ (BLANK) 0-10V 10% dimming driver	■ 14EBL 14 Watt Emergency Ballast
■ CD1 0-10V 1% dimming driver	■ FW 6' Flex Whip Cable
■ CD5 0-10V 5% dimming driver	■ 90 90 CRI
■ EDN Non-dimming electronic driver	■ OC4EX Occupancy Sensor
■ DALI DALI 1% dimming driver	
■ LDE1 Lutron Hi-Lume 1% EcoSystem LED Driver	

XDL4WM 4.0" x 4.5" Linear Wall Mount

SPECIFICATIONS



LED Information

Output	5L	7L	10L	14L
Lumens/Ft*	500	700	1000	1400
System Wattage/Ft	3.125W	4.375W	6.25W	8.75W
Efficacy (Lm/W)	160	160	160	160
CRI	>82	>82	>82	>82
Dimming	0-10V	0-10V	0-10V	0-10V
Color Consistency	>3 SDCM	>3 SDCM	>3 SDCM	>3 SDCM
Rated Life (L70)	>100,000 hrs	>100,000 hrs	>100,000 hrs	>100,000 hrs

* Lumen output was calculated with 4000K LEDs.

Lumen Adjustment Factors 80 CRI

CCT	2700K	3000K	3500K	4000K	5000K
Adjustment	93.5%	95.2%	96.8%	100.0%	103.0%

Lumen Adjustment Factors 90 CRI

CCT	2700K	3000K	3500K	4000K	5000K
Adjustment	77.5%	79.2%	80.8%	85.1%	87.3%

Innovative Features

- Light trap prevents light leaks

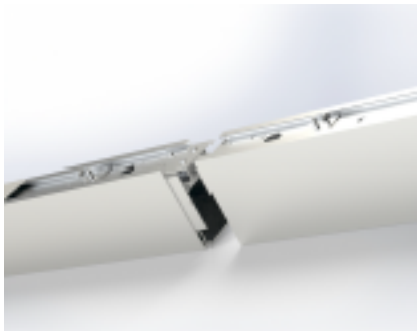

- Board tray quick-release holders



- Board tray connected with tethers

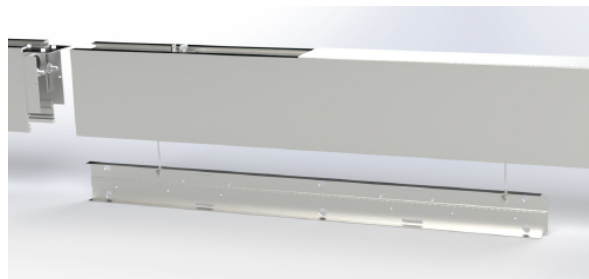

XDL4WM 4.0" x 4.5" Linear Wall Mount

PHOTOMETRICS



File Name: XDL4WM-40-5L-M-W-4.IES
XDL4WM 4.0" X 4.5" LED Wall Mount 5L Output

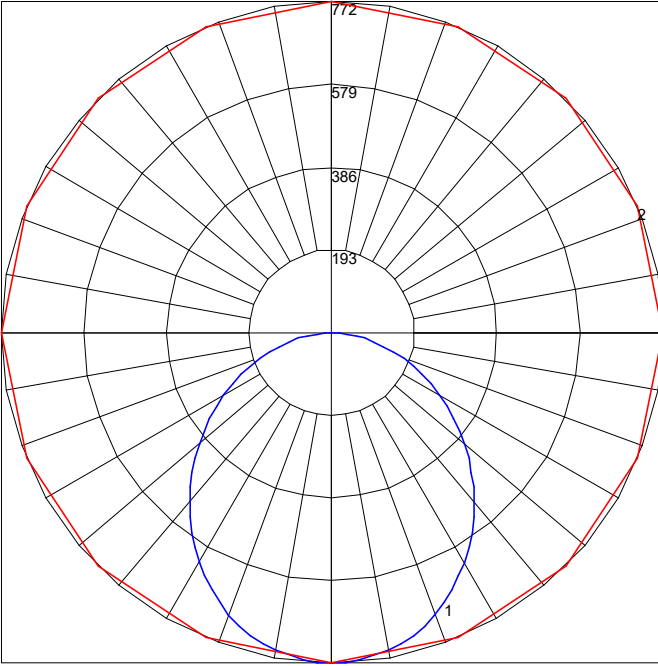

File Name: XDL4WM-40-7L-M-W-4.IES
XDL4WM 4.0" X 4.5" LED Wall Mount 7L Output

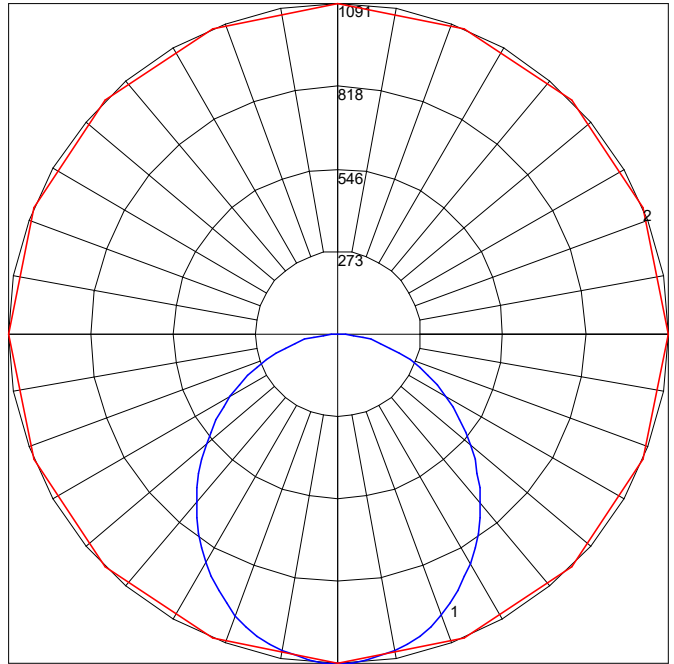

File Name: XDL4WM-40-10L-M-W-4.IES
XDL4WM 4.0" X 4.5" LED Wall Mount 10L Output

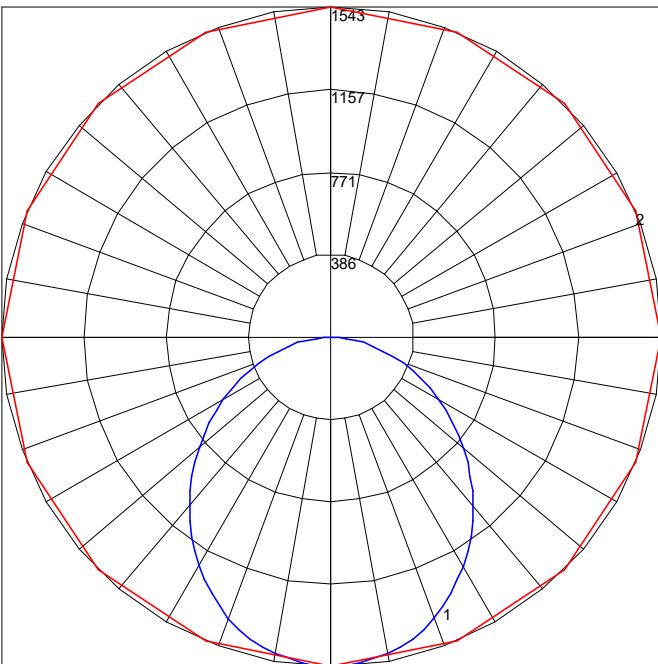

File Name: XDL4WM-40-14L-M-W-4.IES
XDL4WM 4.0" X 4.5" LED Wall Mount 14L Output

